

The D250-X is a cost-effective compression driver with a light-weight and strong phenolic diaphragm designed for medium band (voice) reproduction in indoor sound systems and small PA systems.

The 1" (25 mm) exit fits all Selenium horns with a 25 model number ending (HL14-25, HC23-25, and so on).

Its high density magnetic assembly.

The voice coil is made of high temperature wire wound on Kapton® former to withstand high operating temperatures.

Its precisely engineered diaphragm structure and alignment mechanism allows for easy, reliable and cost effective repair in case of diaphragm failure.

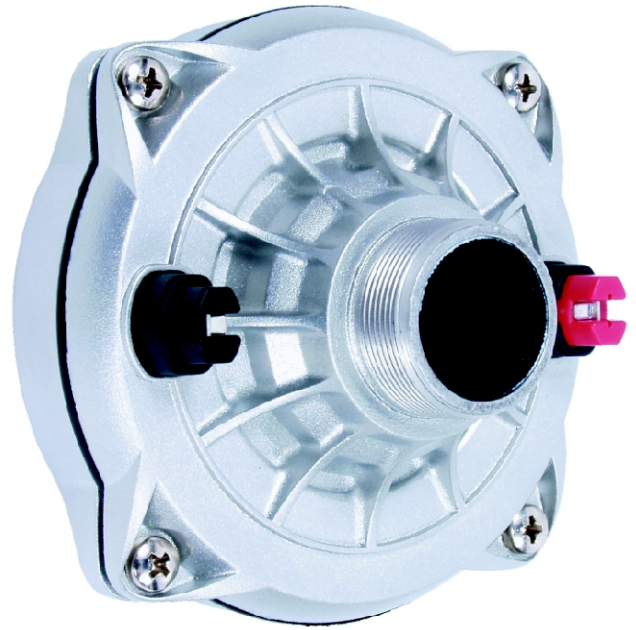

SPECIFICATIONS

Nominal impedance.....	8	Ω
Minimum impedance @ 615 Hz.....	7.2	Ω

POWER USING CROSSOVER (12dB/oct)	ACTIVE	PASSIVE
AES (HPF 500 Hz) ⁵	40.....	W
AES (HPF 1 kHz) ⁵	43.....	W
MUSICAL PROGRAM (HPF 500 Hz) ¹	80.....	150 W
MUSICAL PROGRAM (HPF 1kHz) ¹	86.....	200 W

Sensitivity	
On horn, 2.83V@1m, on axis ²	107 dB SPL
On plane-wave tube, 0.0894V ³	116 dB SPL
Frequency response @ -10 dB.....	400 to 9,000 Hz
Throat diameter.....	25 (1) mm (in)
Diaphragm material.....	Phenolic
Voice coil diameter.....	51 (2) mm (in)
Re.....	6.0 Ω
Flux density.....	1.10 T
Minimum recommended crossover (12 dB / oct).....	500 Hz

¹ Power handling specifications refer to normal speech and/or music program material, reproduced by an amplifier producing no more than 5% distortion. Power is calculated as true RMS voltage squared divided by the nominal impedance of the loudspeaker. This voltage is measured at the input of the recommended passive crossover when placed between the power amplifier and loudspeaker.

Musical Program= 2 x W RMS.

² Measured with HL14-25 horn, 1,000 - 3,500 Hz average.

³ The sensitivity represents the SPL in a 25 mm terminated tube, 600 - 1,500 Hz average.

⁵ Test with duration of 2h with pink noise (from 6dB crest factor) and filtered a decade of often-cut.

ADDITIONAL INFORMATION

Magnet material.....	Barium ferrite
Magnet weight.....	332 (11.7) g (oz)
Magnet diameter x depth.....	102 x 12 (4.02 x 0.47) mm (in)
Magnetic assembly weight.....	978 (2.15) g (lb)
Housing material.....	Aluminum
Housing finish.....	Silver epoxy
Magnetic assembly steel finish.....	Zinc-plated
Voice coil material.....	Copper
Voice coil former material.....	Polyimide (Kapton®)
Voice coil winding length.....	5.7 (18.70) m (ft)
Voice coil winding depth.....	3.0 (0.12) mm (in)
Wire temperature coefficient of resistance (α25).....	0.00404 1/°C
Volume displaced by driver.....	0.5 (0.018) l (ft ³)
Net weight.....	1,290 (2.84) g (lb)
Gross weight.....	1,360 (2.99) g (lb)
Carton dimensions (W x D x H) ..	41 x 30.5 x 10 (16.1 x 12 x 4) cm (in)

MOUNTING INFORMATION

Horn connection.....	Screw-on 1 3/8" - 18 TPI
Connectors.....	Push terminals
Polarity.....	Positive voltage applied to the positive terminal (red) gives diaphragm motion toward the throat

DRIVER x HORN CONNECTION

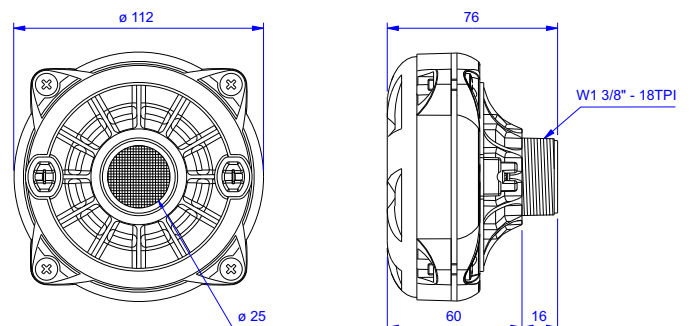
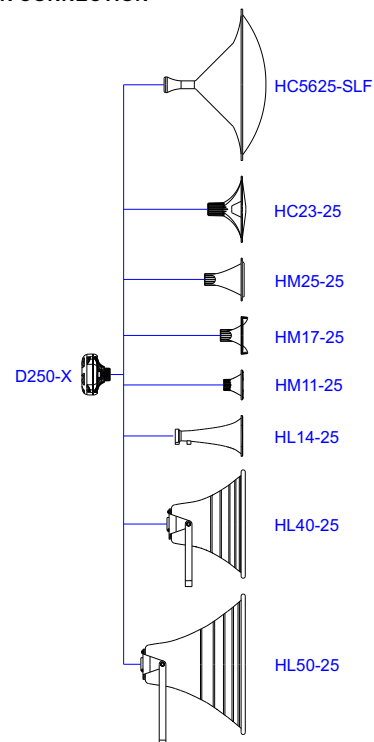

Dimensions in mm.

RESPONSE AND IMPEDANCE CURVES W/ HL14-25 HORN INSIDE AN ANECHOIC CHAMBER, 1 W / 1 m

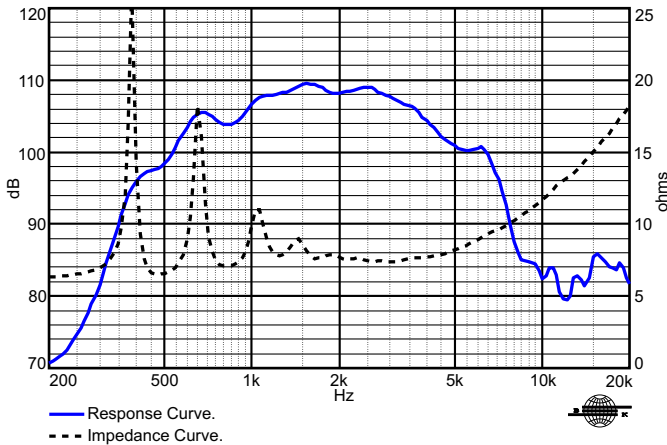

HARMONIC DISTORTION CURVES W/ HL14-25 HORN, 5 W / 1 m.

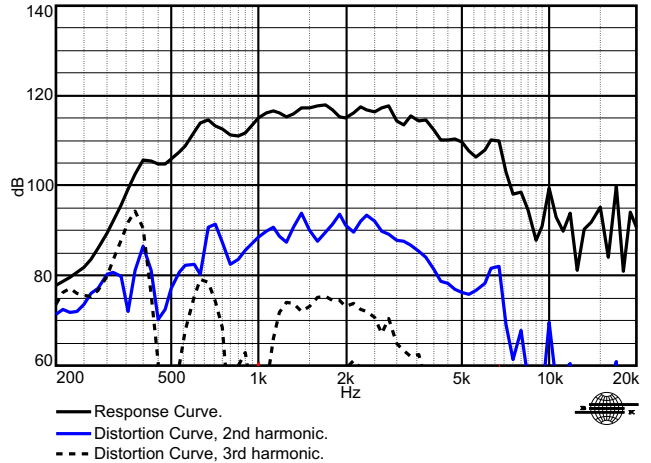

RESPONSE AND IMPEDANCE CURVES W/ PLANE-WAVE TUBE, 1 mW

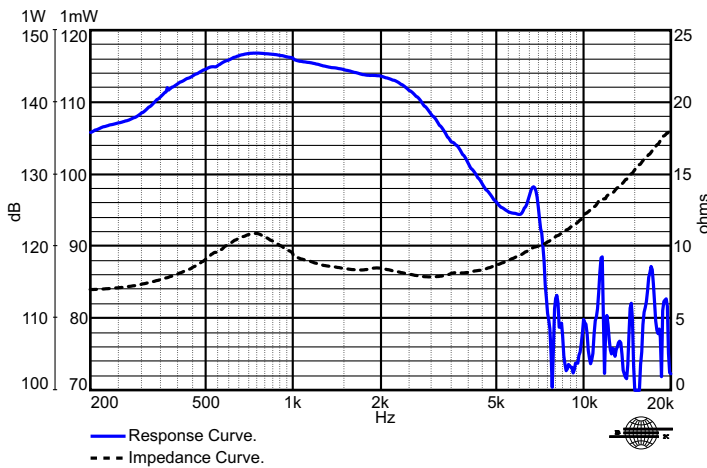

Frequency response and impedance curves measured with 25 mm terminated plane-wave tube.

POLAR RESPONSE CURVES

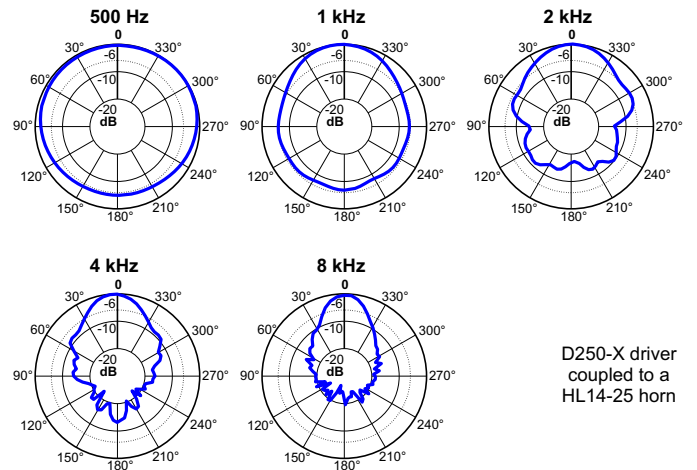

D250-X driver coupled to a HL14-25 horn

— Polar Response Curve.

HARMONIC DISTORTION CURVES W/ HL14-25 HORN, 1 W / 1 m.

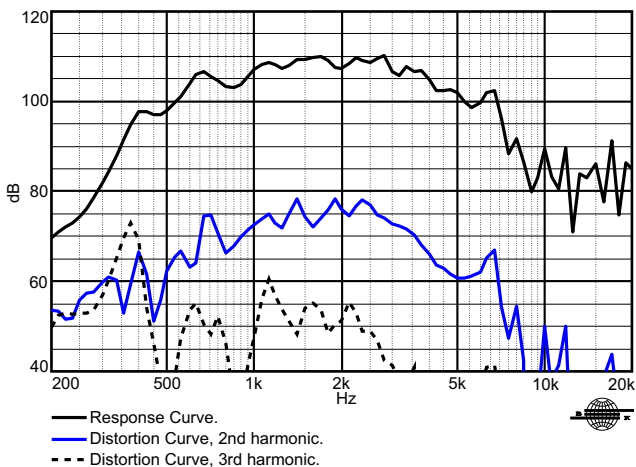

HOW TO CHOOSE THE RIGHT AMPLIFIER

The power amplifier must be able to supply twice the RMS driver power. This 3 dB headroom is necessary to handle the peaks that are common to musical programs. When the amplifier clips those peaks, high distortion arises and this may damage the transducer due to excessive heat. The use of compressors is a good practice to reduce music dynamics to safe levels.

FINDING VOICE COIL TEMPERATURE

It is very important to avoid maximum voice coil temperature. Since moving coil resistance (R_e) varies with temperature according to a well known law, we can calculate the temperature inside the voice coil by measuring the voice coil DC resistance:

$$T_B = T_A + \left(\frac{R_B}{R_A} - 1 \right) \left(T_A - 25 + \frac{1}{\alpha_{25}} \right)$$

T_A, T_B = voice coil temperatures in °C.

R_A, R_B = voice coil resistances at temperatures T_A and T_B , respectively.

α_{25} = voice coil wire temperature coefficient at 25 °C.